

2022 CEOS International TIR radiometer comparison

FRM4SST: ISFRN Workshop

22/04/2024 University of Southampton

Yoshiro Yamada¹, Subrena Harris¹, Michael Hayes¹, Rob Simpson¹, Werenfrid Wimmer², Raymond Holmes², Tim Nightingale³, Arrow Lee³, Nis Jepsen⁴, Nicole Morgan⁵, Frank-M. Göttsche⁶, Raquel Niclòs⁷, Martín Perelló⁷, Vicente Garcia-Santos⁷, Craig Donlon⁸, and Nigel Fox¹

1. National Physical Laboratory, Teddington, UK,
2. Univ. of Southampton, Southampton, UK,
3. STFC Rutherford Appleton Laboratory, Oxon, UK,
4. Danish Meteorological Institute, Copenhagen, Denmark,
5. CSIRO / Australian Bureau of Meteorology, Battery Point, Australia,
6. Karlsruhe Institute of Technology, Eggenstein-Leopoldshafen, Germany,
7. Univ. of Valencia, Valencia, Spain,
8. European Space Agency, Noordwijk, The Netherlands

5th CEOS TIR radiometer comparison (June 2022)



➤ Objective

- To establish degree of equivalence of radiometric scales between field deployed ship-borne TIR radiometers
- Ensure robust traceability to SI

➤ Past Comparisons: 2001 (Miami), 2009 (NPL & Miami), 2016 (NPL)

➤ Overview of the comparison:

Laboratory-based and field-based exercise to compare

- against the SI via NPL references (lab-comparison)
 - ✓ Blackbodies viewed by reference radiometer
 - ✓ TIR radiometers viewing reference blackbodies
- against each other (field-comparison).
 - ✓ TIR radiometers as used viewing the ocean

Outline was presented at the previous ISFRN WS (2022).

Comparison results are presented in this presentation.

Participants

Attendee	Institute	Short version	Lab comp.		Field comp.
			Blackbody	Radiometer	
Yoshiro Yamada Subrena Harris	National Physical Laboratory United Kingdom	NPL	Pilot*1	Pilot*1	(Pilot)
Werenfrid Wimmer Raymond Holmes	National Oceanography Centre United Kingdom	UoS	✓	✓	✓
Tim Nightingale Arrow Lee	STFC Rutherford Appleton Laboratory United Kingdom	RAL	✓	✓	✓
Nis Jepsen	Danish Meteorological Institute Denmark	DMI		✓	✓
Nicole Morgan	CSIRO / Australian Bureau of Meteorology Australia	CSIRO	✓	✓	✓
Frank-M. Götsche	IMK-ASF / Karlsruhe Institute of Technology Germany	KIT	✓	✓	✓
Raquel Niclòs Martin Perello Vicente Garcia-Santos	University of Valencia Spain	UoV	✓	✓	✓

*1: The pilot provided the reference values for the laboratory comparisons

Issues encountered in previous comparison

- The high-emissivity NPL reference standard blackbody aperture was too small
 - alignment covering the FOV was difficult for some of the radiometers
- The time allocated to each participant for measuring the blackbody was too short



This comparison

- Blackbody comparison: a transfer radiometer is introduced to measure the participant's blackbodies – to increase flexibility
- Radiometer comparison: a second variable temperature blackbody with a larger aperture is introduced – to improve efficiency and accuracy

Standard facilities for *blackbody* comparison

Radiometer specifications

AMBER (Absolute Measurements of Blackbody Emitted Radiance) (reference standard)

Heitronics TRT-IV.82 *New* (transfer standard)

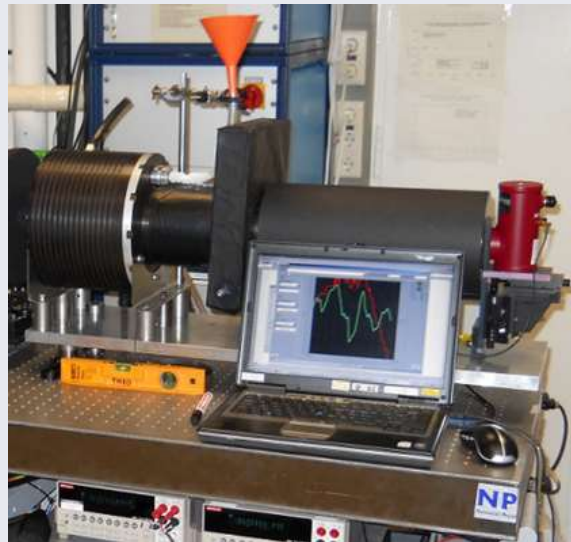

Wavelength	10.1 μm (9 μm – 11 μm)	8 μm - 14 μm
Target size	ϕ 5 mm	ϕ 8.7 mm
Measurement distance	70 mm	503 mm
Effective lens diameter	ϕ 13 mm	ϕ 57 mm
Scale realization	Through relative spectral response measurement and a fixed-point blackbody measurement at the Ga melting point.	By comparison with AMBER

Standard facilities for *radiometer* comparison

Variable-temperature blackbody specifications

Ammonia heatpipe BB

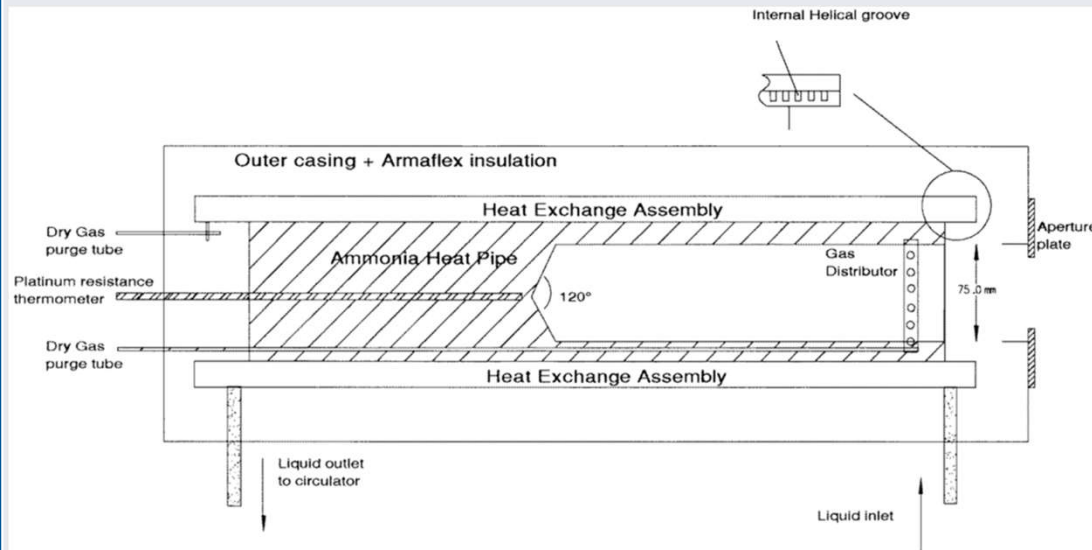

Stirred liquid bath BB *New*

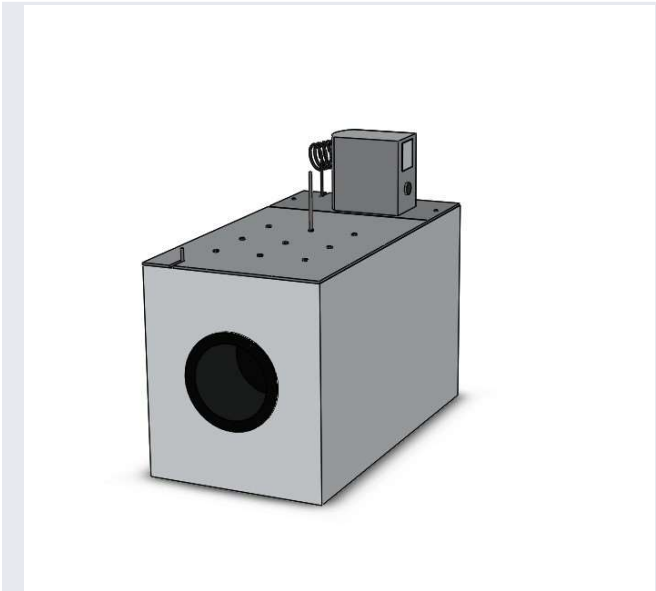

Aperture diameter

ϕ 75 mm max

ϕ 160 mm max

Aperture distance from front panel

75 mm

35 mm

Emissivity

0.9993

>0.99965 @10 μ m

Temperature range

-40 °C – 50 °C

-10 °C – 40 °C

Reference thermometer

Standard platinum resistance thermometer

Platinum resistance thermometer

Traceability of reference instruments

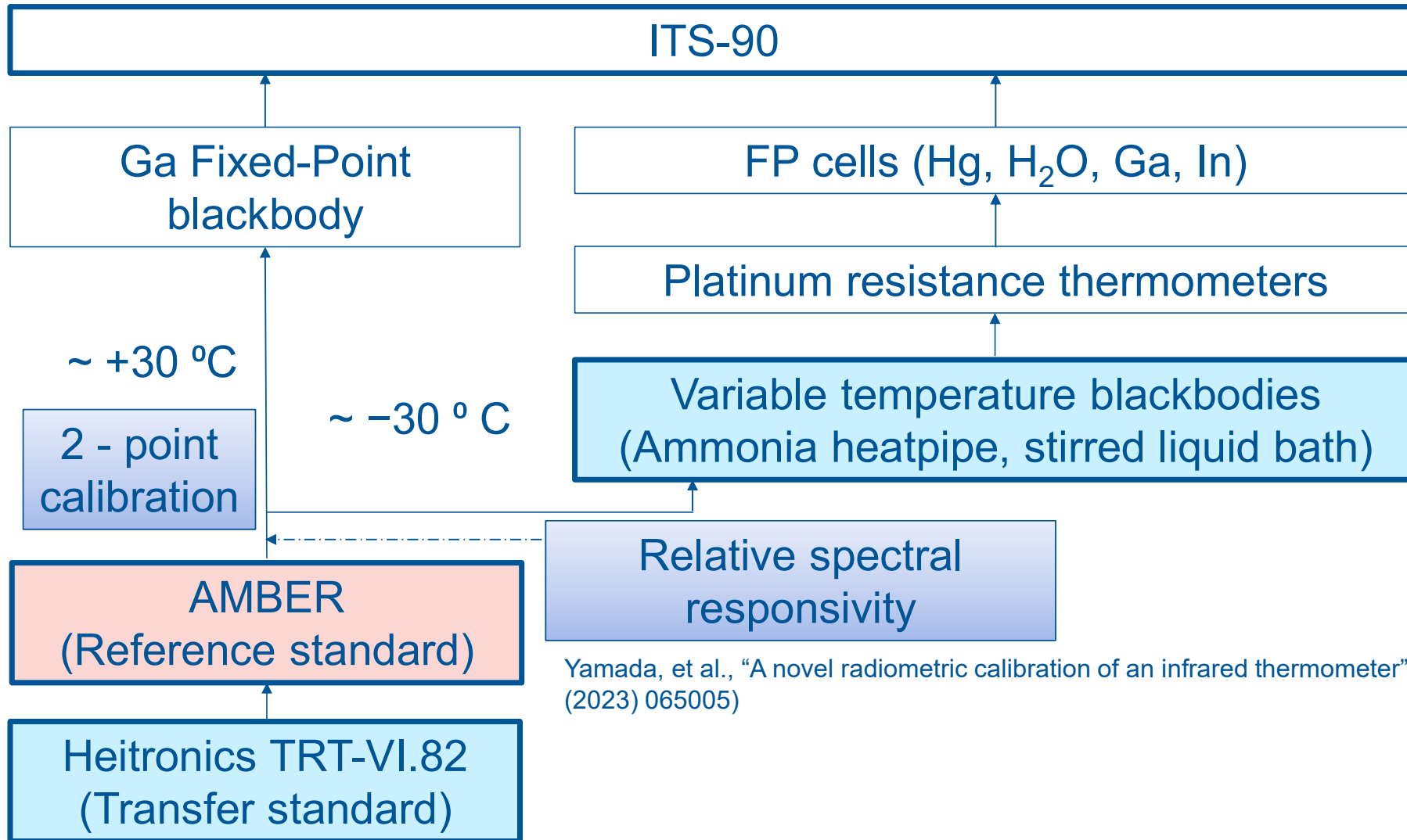

Yamada, et al., "A novel radiometric calibration of an infrared thermometer", *Metrologia*, 60 (2023) 065005

Participant instrument types:

Blackbodies (BBs)

- Stirred liquid bath ('CASOTS I', 'CASOTS II')
- Commercial apparatus (Landcal P80P)

Radiometers

- Dedicated systems ('SISTeR', 'ISAR')
- Commercial instruments (CIMEL, Heitronics)

Measurement temperature points

Comparison type	Nominal temperature / °C
Blackbody comparison *2	10, 15, 20, 25, 30, 35, 40, 45, 50, (55, 60)
Radiometer comparison	
Ammonia heatpipe (NH3-) BB *2	-30, -15, 0, 30, 35, 40, 50
Stirred liquid bath (SL-) BB	0, 10, 20, 30

*2: Higher temperature points are included from LST interest

Laboratory comparison

13th -17th June, 2022, @ NPL, Teddington, UK

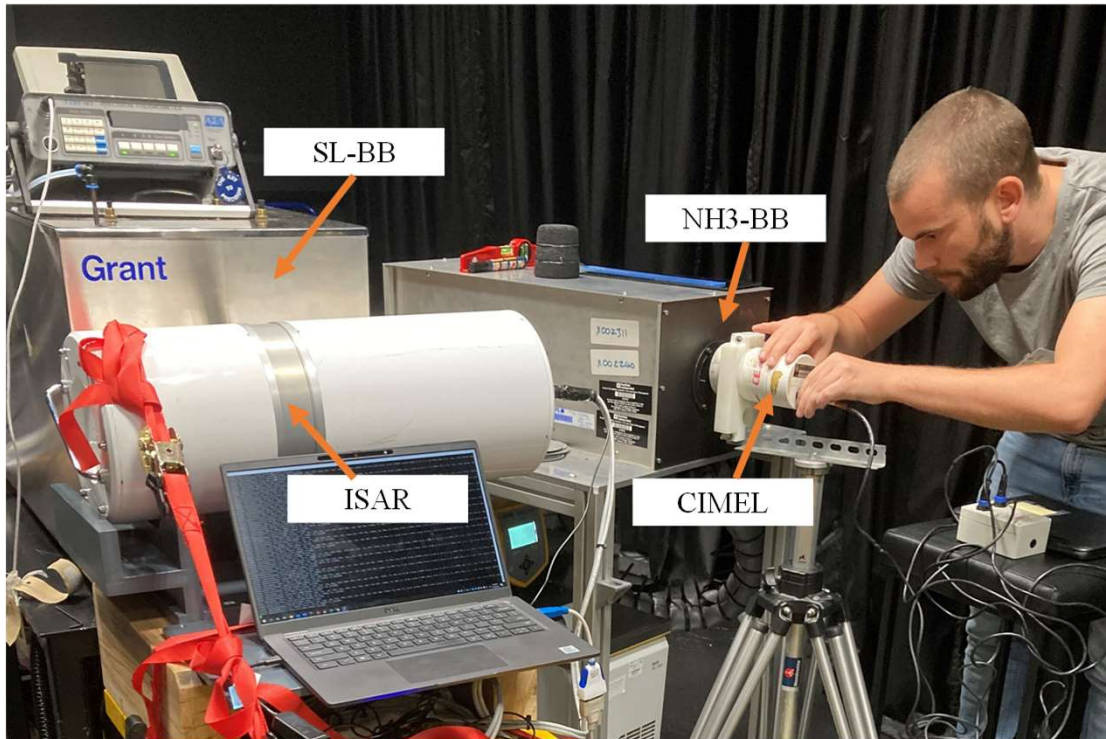

Radiometer comparison

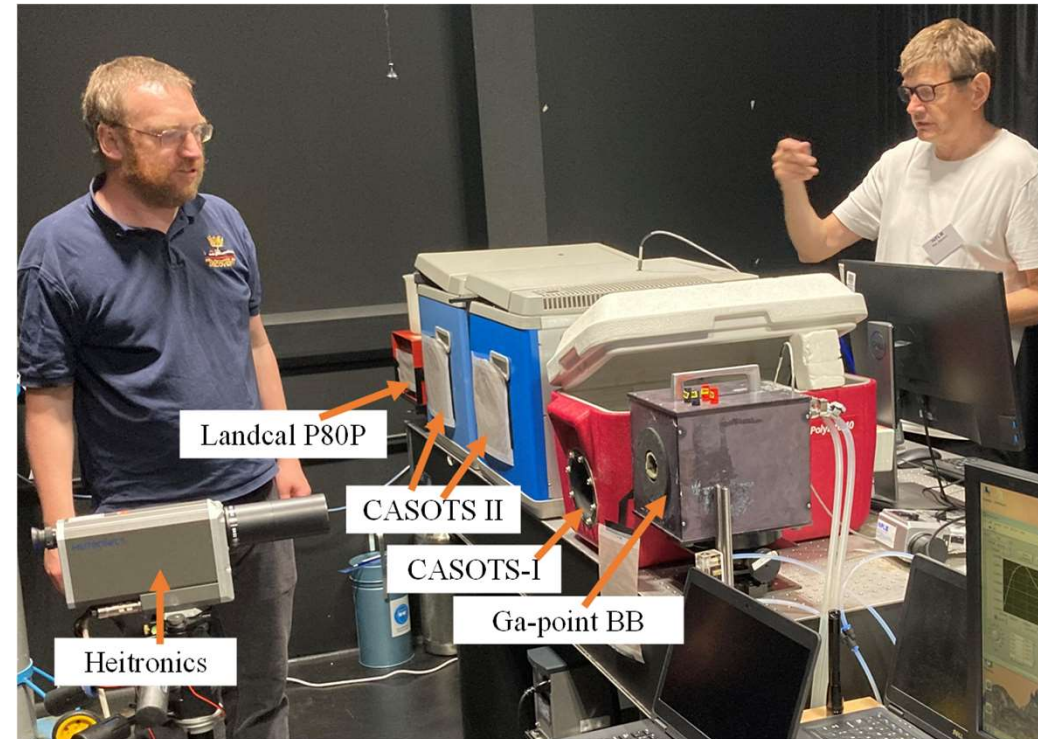

Blackbody comparison

Results for laboratory BB comparison

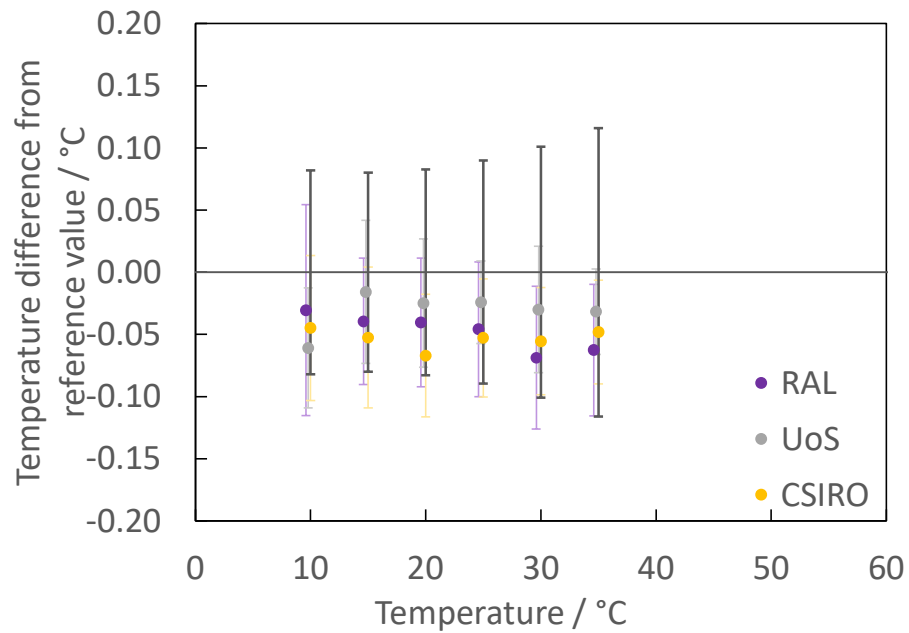

a) Stirred liquid baths

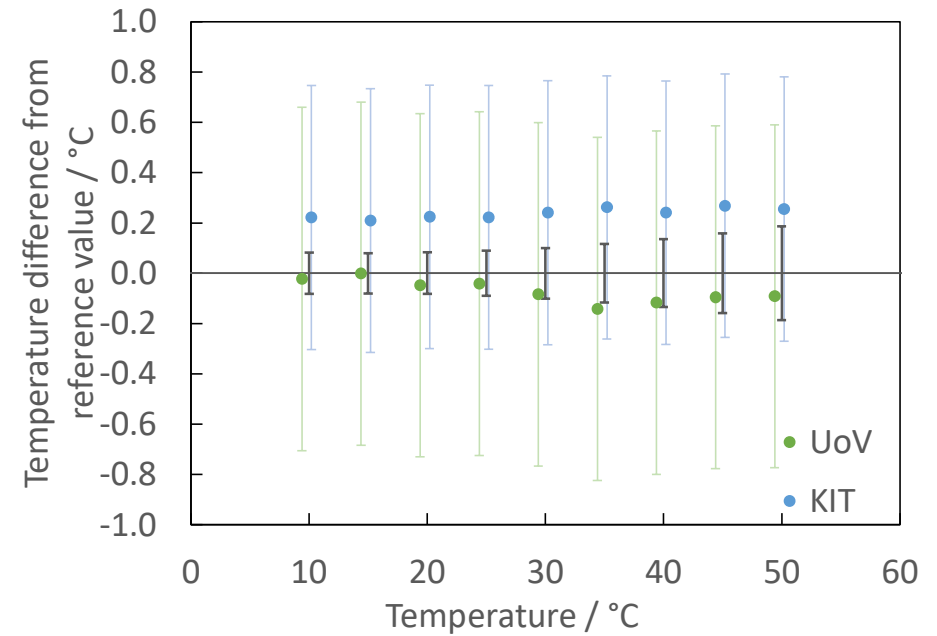

b) Commercial apparatus

Error bars are the standard uncertainties ($k = 1$)

Results for laboratory radiometer comparison

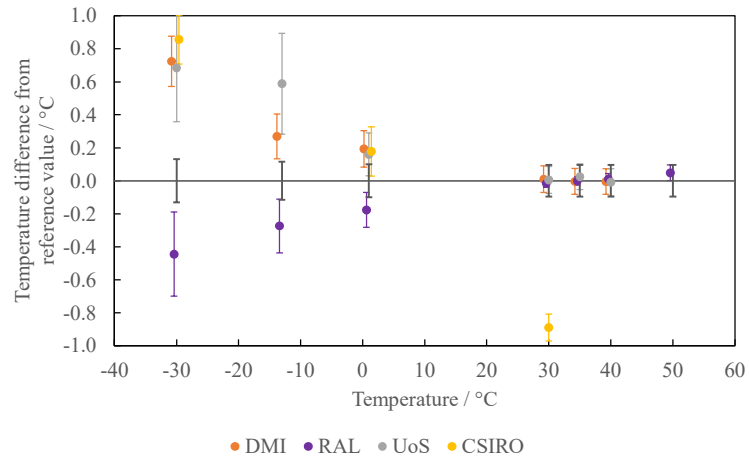

a) NH3-BB with dedicated systems

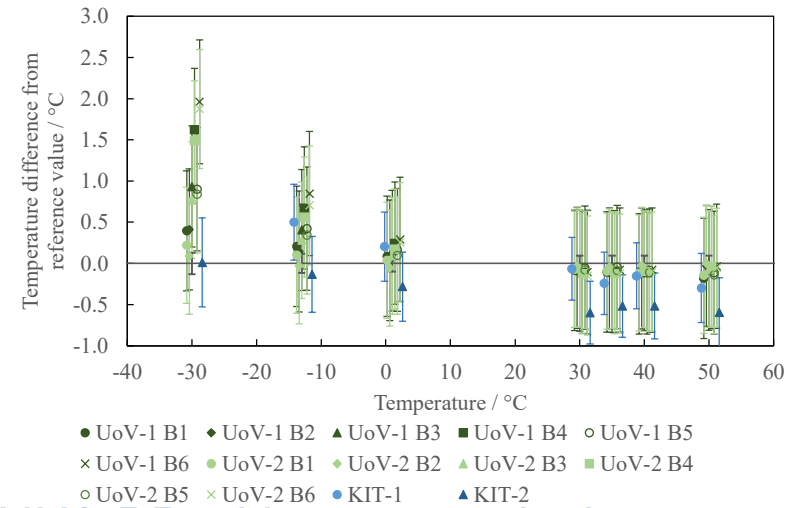

b) NH3-BB with commercial instruments

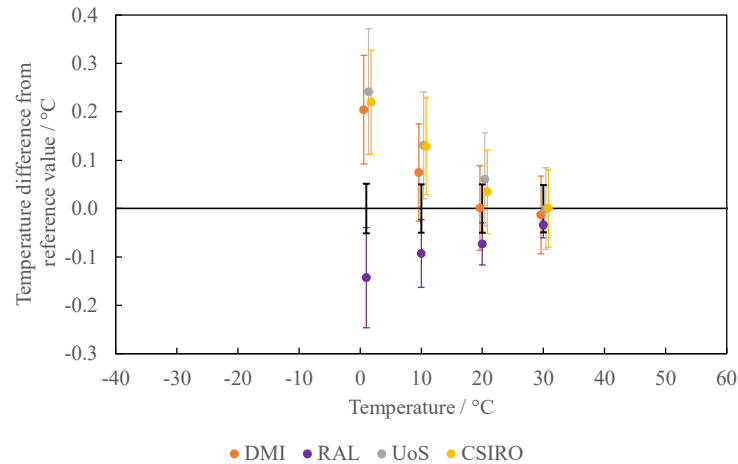

c) SL-BB with dedicated systems

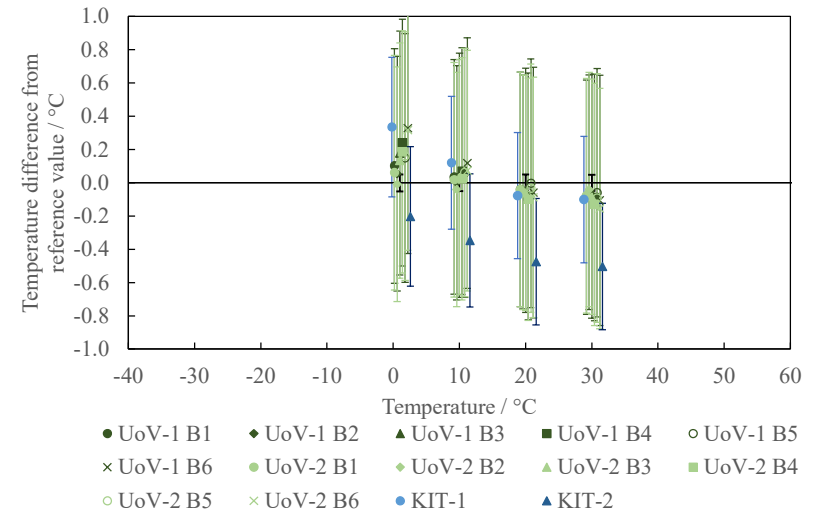

d) SL-BB with commercial instruments

Error bars are the standard uncertainties ($k = 1$)

Field comparison 20th -24th June, 2022 Boscombe Pier, Bournemouth, UK

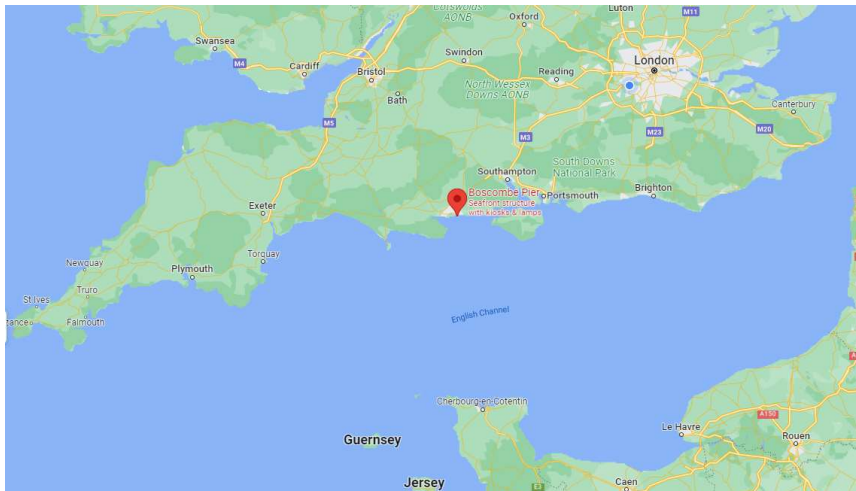

Location

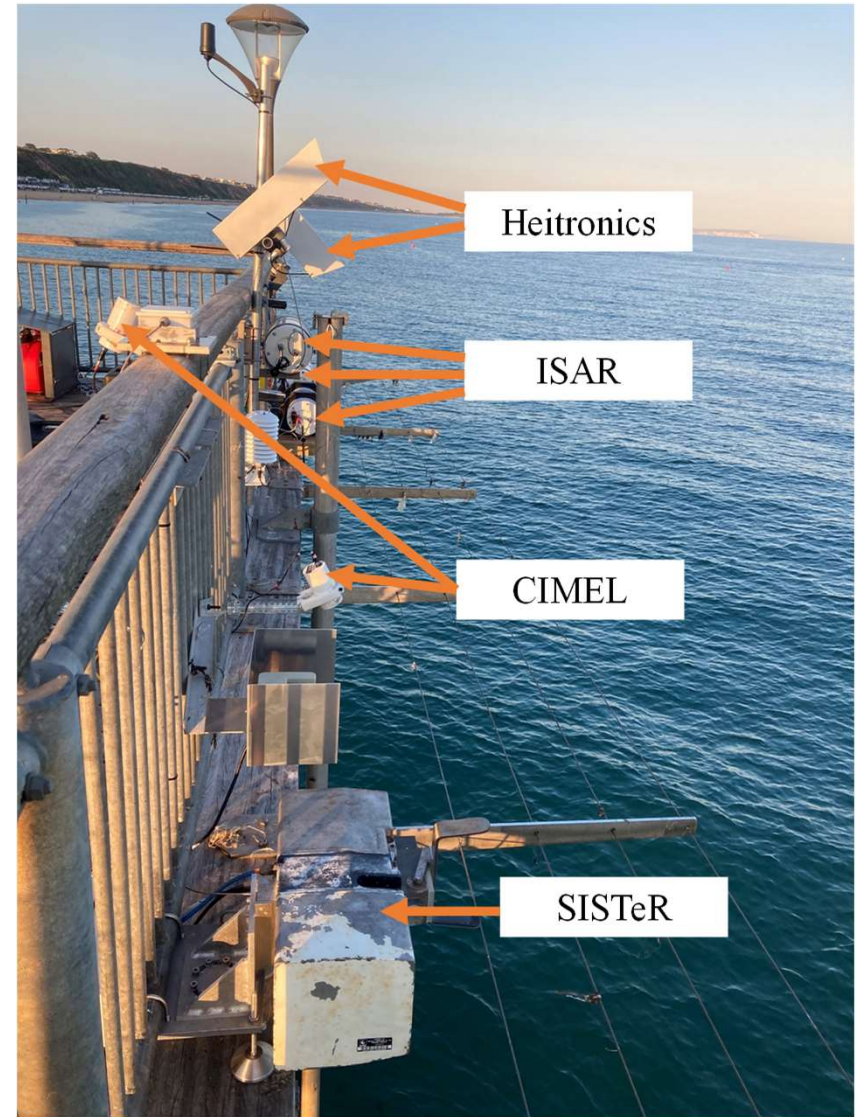

Radiometers installed at pier

Results for field radiometer comparison

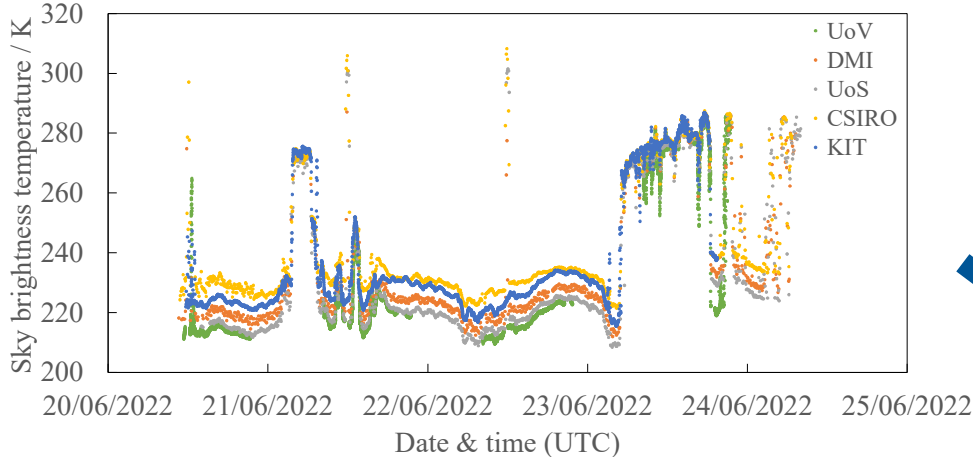

a) Sky brightness temperature

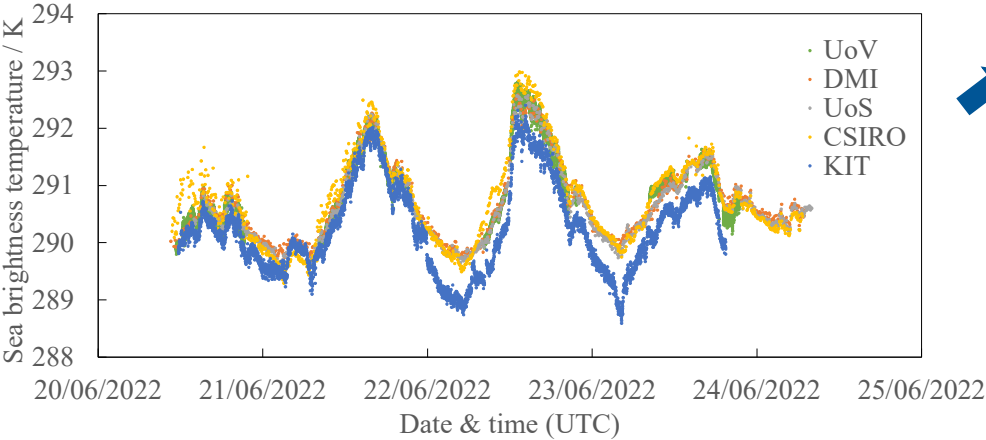

b) Sea brightness temperature

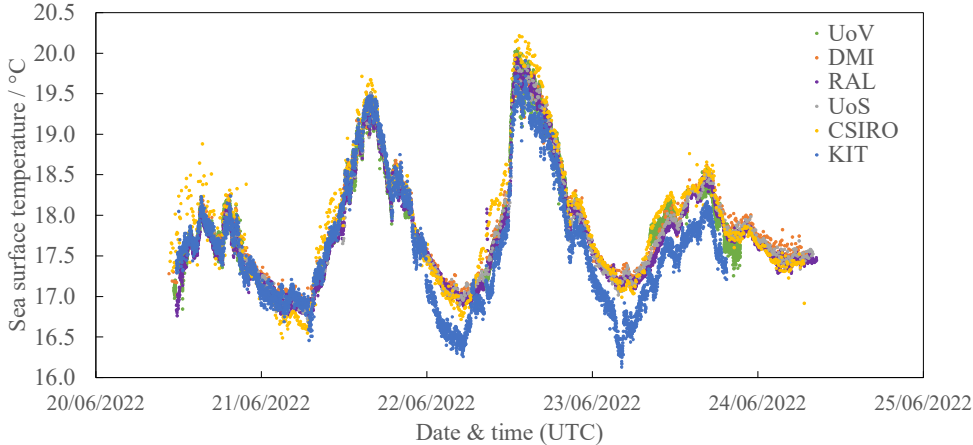

c) Derived SSTskin values.

Results for field radiometer comparison

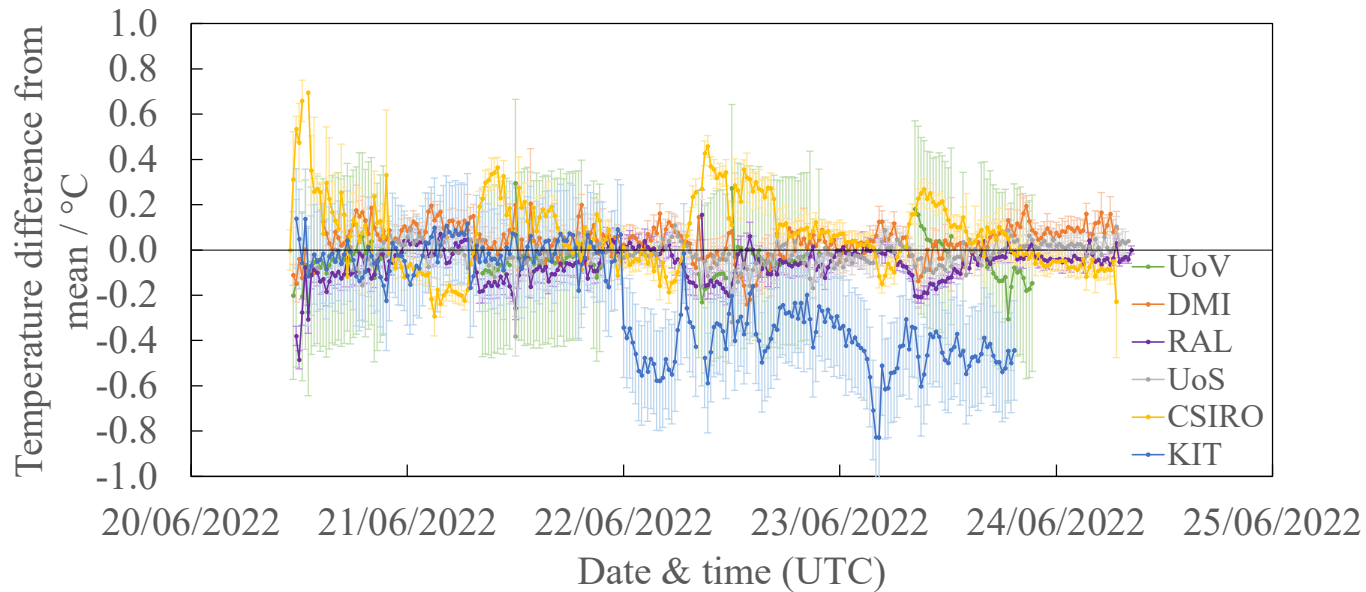

b) Difference of sea surface temperature averaged over twenty minutes from the reference value. Error bars are the expanded uncertainties ($k = 2$)

Conclusions

- Laboratory BB comparison: All participants' reported values agreed with the reference value within the uncertainties at all temperatures.
- Laboratory radiometer comparison: At zero and sub-zero degrees, the uncertainty estimation needs to be enlarged for all radiometers. This will not cause a problem in practice, as this temperature range is only necessary for sky radiance measurement.
- Field comparison: All participants' reported values agreed with the reference value within the uncertainties, with a two-times improvement in agreement compared to the 2016 comparison. An abrupt shift of KIT's SST data readings can be seen, which shows the importance of using an internal reference BB.

Full reports can be found in:

https://ships4sst.org/sites/shipborne-radiometer/files/documents/FRM4SST-CRICR-NPL-001_ISSUE-1.pdf, .../FRM4SST-CRICR-NPL-002_ISSUE-1.pdf, .../FRM4SST-CRICR-NPL-003_ISSUE-1.pdf

Publications:

Yamada, et al., "2022 CEOS International Thermal Infrared Radiometer Comparison: Part I: Laboratory Comparison of Radiometers and Blackbodies" *J. Atmos. Ocean Technol.*, 41 (2024) 295-307

Yamada, et al., "2022 CEOS International Thermal Infrared Radiometer Comparison: Part II: Field Comparison of Radiometers" *J. Atmos. Ocean Technol.*, 41 (2024) 309-318

